

ou

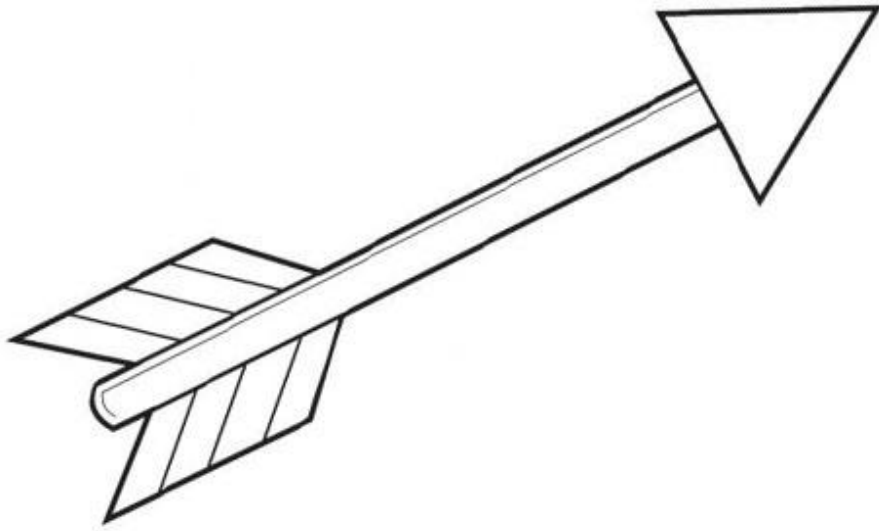

un loup

è È



une flèche

e

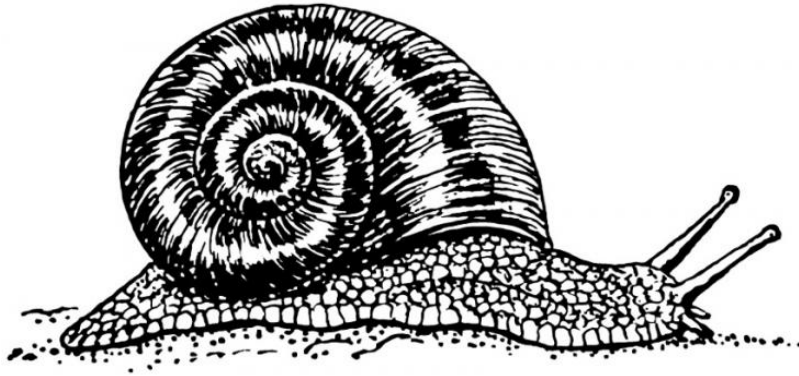

un **e**scargot

ai

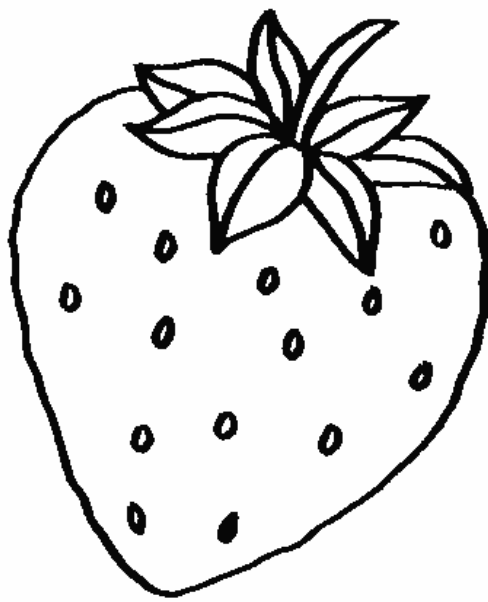

une fraise

ê

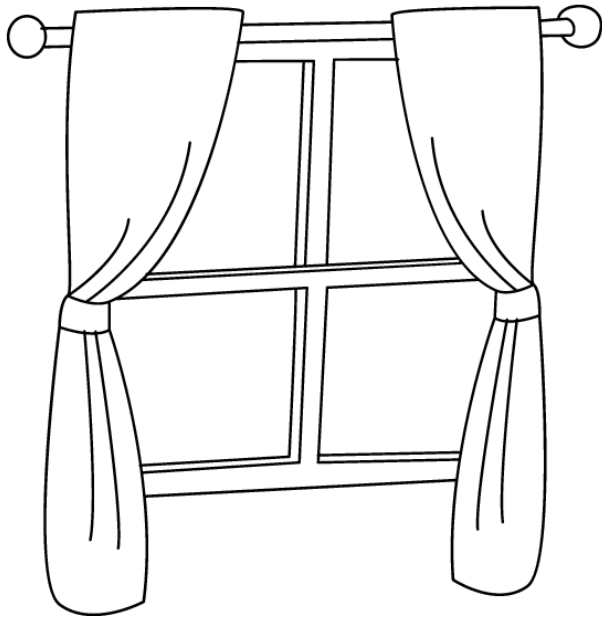

une fenê**tre**

ei

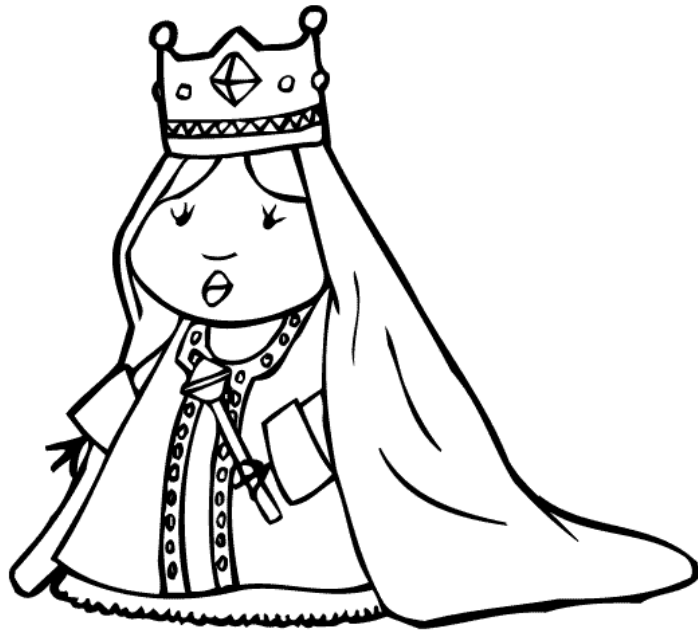

une reine

in

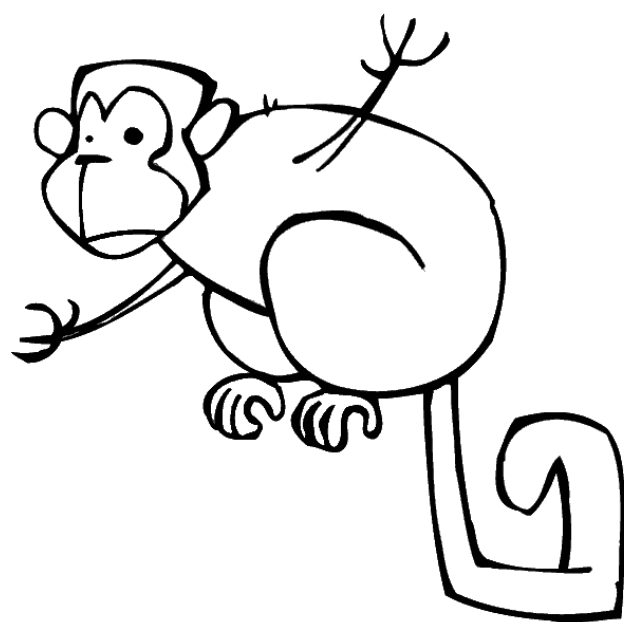

un singe

en

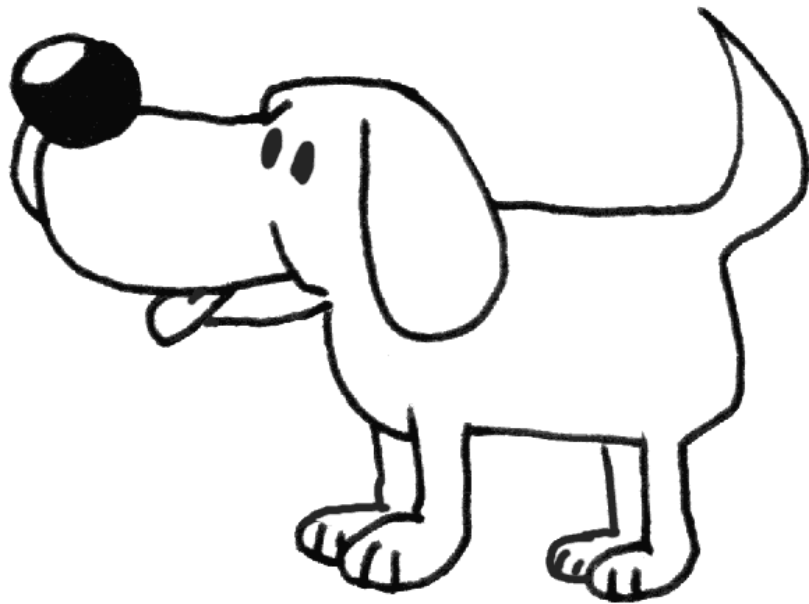

un chien

ain

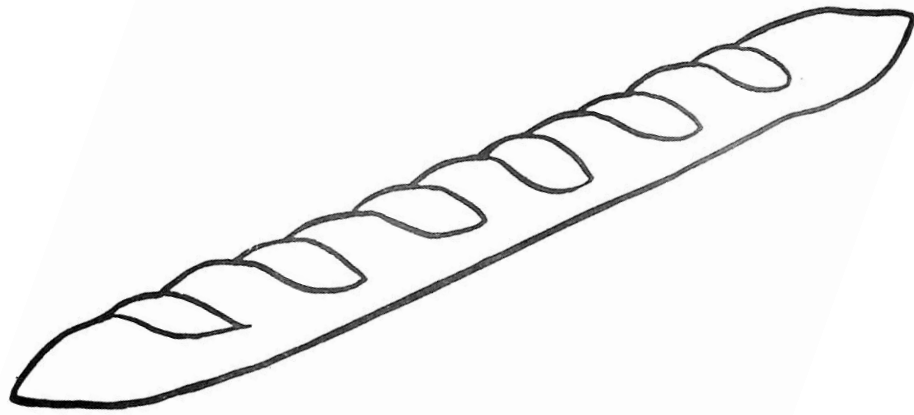

du pain

ein

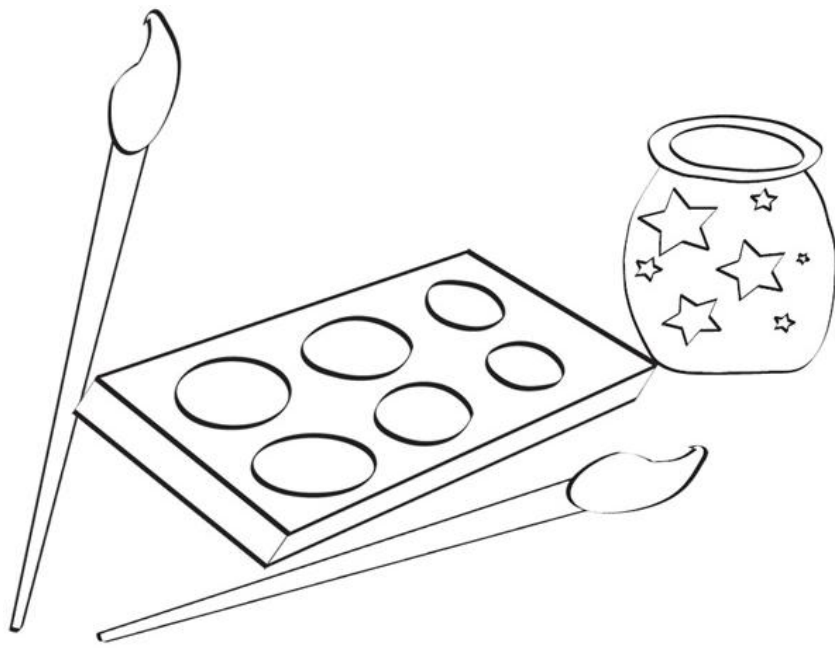

de la peinture

im



un timbre

oi

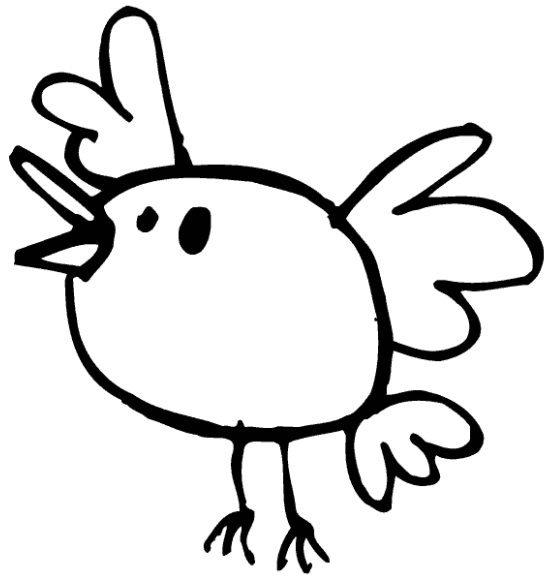

un oiseau

oin

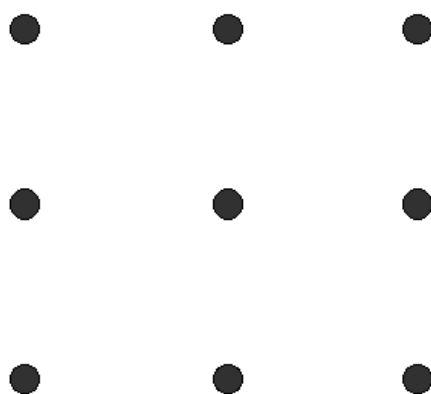

des points

Handwriting practice lines consisting of six horizontal lines. The top two lines are blue, the middle line is purple, and the bottom two lines are blue.

e

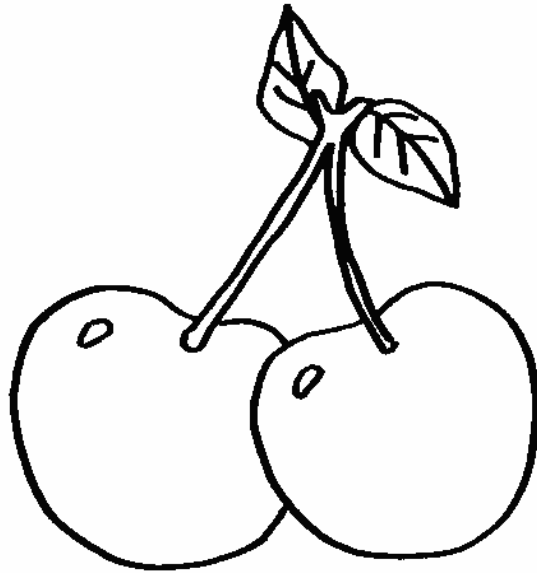

des cerises

eu

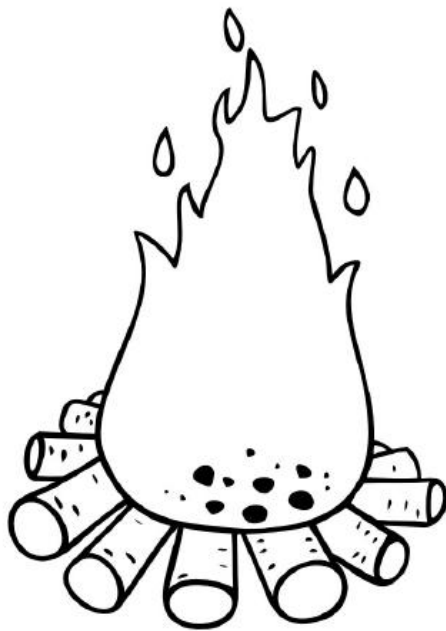

du feu

œu



un nœud

eu

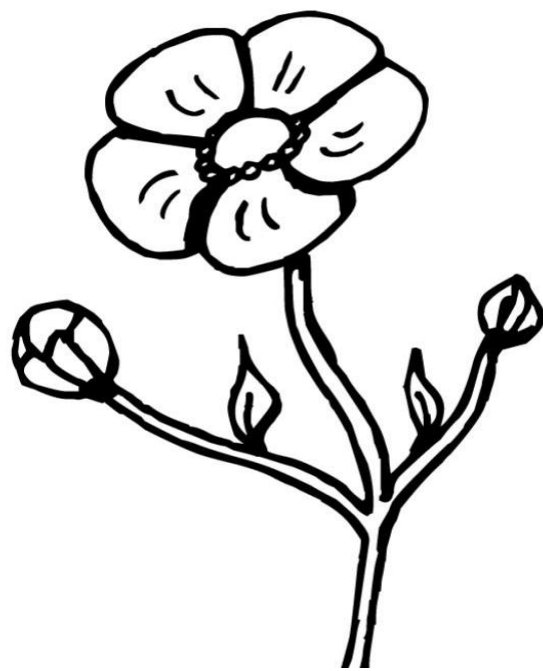

une fleur

œu

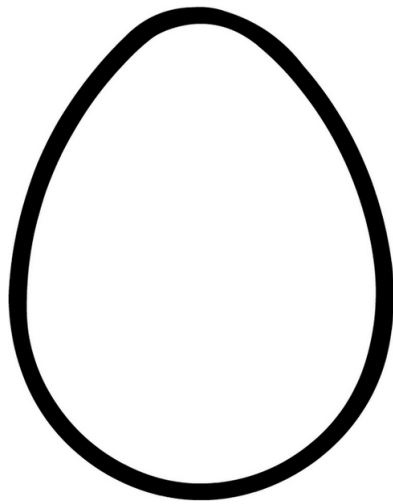

un œuf

y Y

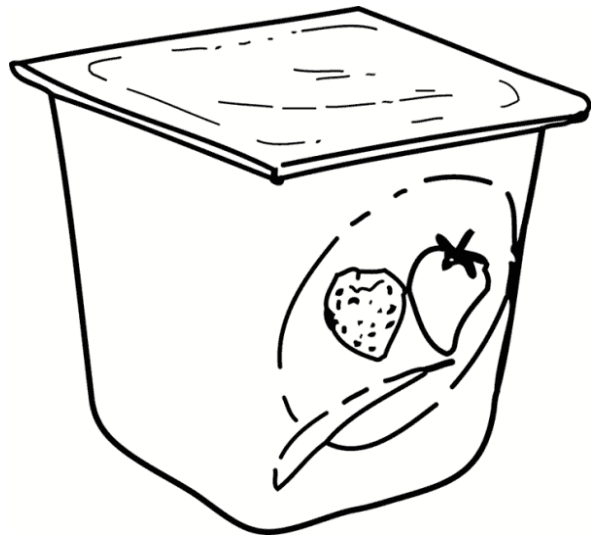

un yaourt

il

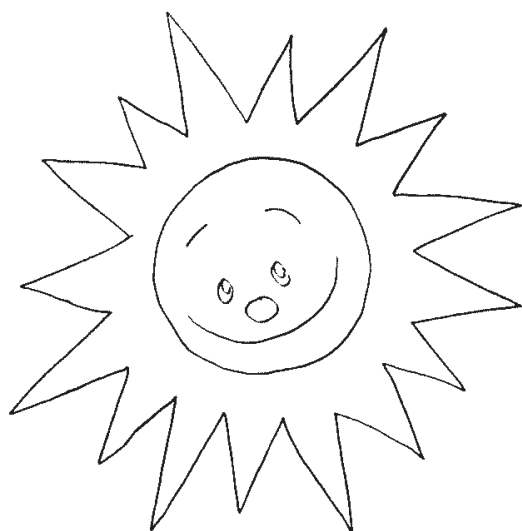

le soleil

ill

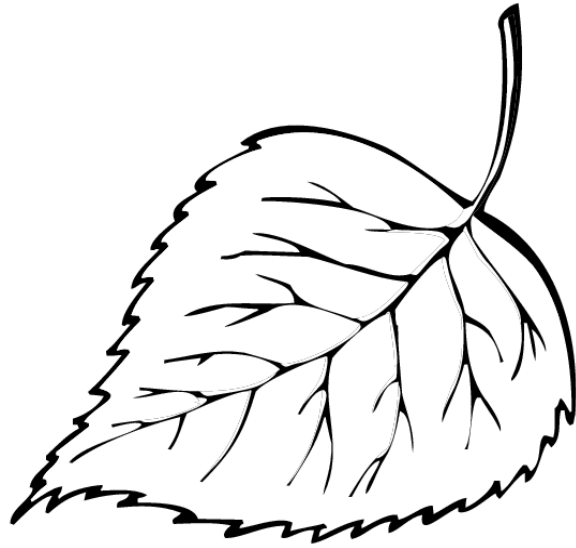

une feuille

un

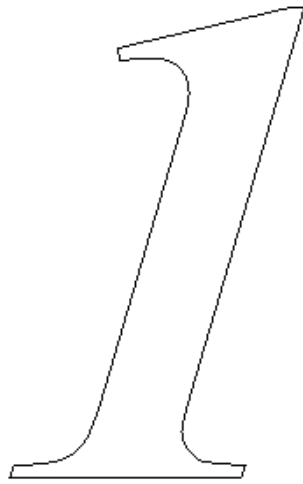

un